

Solero



Solero Sombrillas ESPAÑA

Acoter System
c/ Níquel 4, nave 25
28863 Cobeña (Madrid)

Tlf: +34.91 620 77 77
comercial@acotersystem.com

Solero

Serie 9000 Max



Solero®

Serie 9000 Max - Detalles

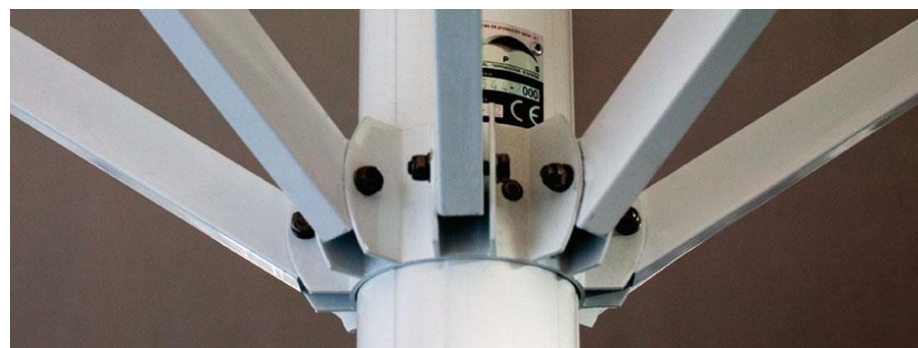
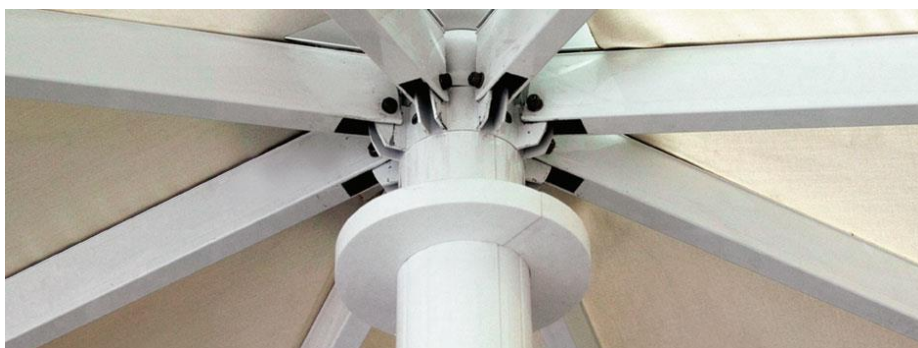
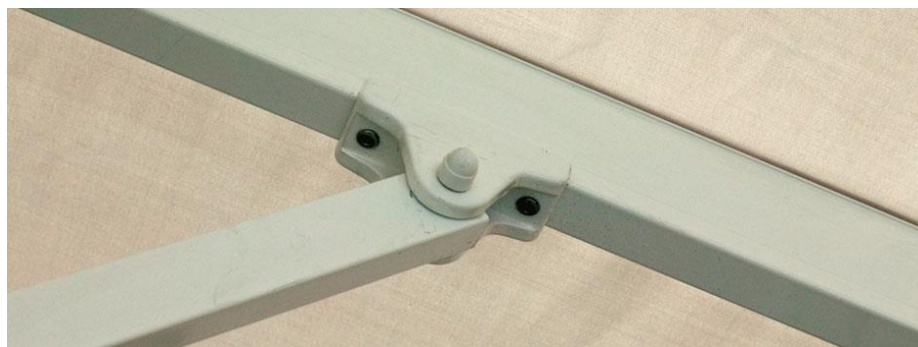

Serie 9000 Max – Datos técnicos



- Mástil Ø 90mm, rodeado por 8 brazos
- Perfilería aluminio lacado blanco
- Tornillería acero Inox. A-2
- Apertura mediante manivela
- Faldón / bambalina opcional
- Tejido Acrílico 300 gr tintado en masa

Serie 9000 Max - Medidas



Solero

Serie 9000 Max - Medidas

	DESCRIPCIÓN	PESO	A	B	C	D	E	F	EMBALAJE
	Octogonal 4.0 m	45 Kg	4000	3695	2790	2200	3870	950	350x350x3970
	Octogonal 4.5 m	50 Kg	4500	4150	2880	2200	4260	950	350x350x4360
	Octogonal 5.0 m	55 Kg	5000	4620	2940	2200	4330	950	350x350x4430
	Octogonal 5.5 m	60 Kg	5500	5080	3010	2200	4570	950	350x350x4670
	Octogonal 6.0 m	65 Kg	6000	5540	3070	2200	4820	950	350x350x4920
	Cuadrado 2.5 x 2.5 m	40 Kg	2500	2500	2560	2200	3400	950	350x350x3400
	Cuadrado 3.0 x 3.0 m	44 Kg	3000	3000	2640	2200	3515	950	350x350x3515
	Cuadrado 3.5 x 3.5 m	48 Kg	3500	3500	2740	2200	3830	950	350x350x3930
	Cuadrado 4.0 x 4.0 m	52 Kg	4000	4000	2790	2200	3870	950	350x350x3970
	Cuadrado 4.5 x 4.5 m	58 Kg	4500	4500	2880	2200	4260	950	350x350x4360
	Cuadrado 5.0 x 5.0 m	65 Kg	5000	5000	2940	2200	4330	950	350x350x4430
	Cuadrado 5.5 x 5.5 m	73 Kg	5500	5500	3010	2200	4570	950	350x350x4670
	Cuadrado 6.0 x 6.0 m	80 Kg	6000	6000	3070	2200	4820	950	350x350x4920
	Rectangular 2.0 x 2.5 m	38 Kg	2500	2000	2580	2200	3210	950	350x350x3310
	Rectangular 2.0 x 3.0 m	40 Kg	3000	2000	2660	2200	3410	950	350x350x3510
	Rectangular 2.5 x 3.0 m	42 Kg	3000	2500	2660	2200	3410	950	350x350x3510
	Rectangular 2.5 x 3.5 m	44 Kg	3500	2500	2740	2200	3830	950	350x350x3930
	Rectangular 3.0 x 3.5 m	46 Kg	3500	3000	2740	2200	3830	950	350x350x3930
	Rectangular 3.0 x 4.0 m	48 Kg	4000	3000	2790	2200	3870	950	350x350x3970
	Rectangular 3.0 x 4.5 m	50 Kg	4500	3000	2880	2200	4260	950	350x350x4360
	Rectangular 3.0 x 5.0 m	55 Kg	5000	3000	2940	2200	4330	950	350x350x4430
	Rectangular 3.5 x 4.0 m	50 Kg	4000	3500	2790	2200	3870	950	350x350x3970
	Rectangular 3.5 x 4.5 m	55 Kg	4500	3500	2880	2200	4260	950	350x350x4360
	Rectangular 3.5 x 5.0 m	57 Kg	5000	3500	2940	2200	4340	950	350x350x4360
	Rectangular 4.0 x 4.5 m	57 Kg	4500	4000	2880	2200	4260	950	350x350x4360
	Rectangular 4.0 x 5.0 m	60 Kg	5000	4000	2940	2200	4330	950	350x350x4430
	Rectangular 4.5 x 5.0 m	62 Kg	5000	4500	2940	2200	4330	950	350x350x4430
	Rectangular 4.5 x 5.5 m	65 Kg	5500	4500	3010	2200	4570	950	350x350x4670
	Rectangular 5.0 x 5.5 m	70 Kg	5500	5000	3010	2200	4570	950	350x350x4670
	Rectangular 5.0 x 6.0 m	75 Kg	6000	5000	3070	2200	4820	950	350x350x4920
	Rectangular 5.5 x 6.0 m	78 Kg	6000	5500	3070	2200	4820	950	350x350x4920

Serie 9000 Max - Precios

	SERIE 9000 MAX	ACRÍLICO CRUDO - PVC BLANCO	ACRÍLICO / PVC + FALDON
	Octogonal 4.0 m	3.236,99	3.342,59
	Octogonal 4.5 m	3.506,62	3.639,01
	Octogonal 5.0 m	3.731,46	3.845,86
	Octogonal 5.5 m	3.824,04	3.973,64
	Octogonal 6.0 m	3.908,17	4.041,54
	Cuadrado 3.0 x 3.0 m	3.332,03	3.430,13
	Cuadrado 3.5 x 3.5 m	3.332,03	3.430,13
	Cuadrado 4.0 x 4.0 m	3.426,46	3.556,94
	Cuadrado 4.5 x 4.5 m	3.696,26	3.853,49
	Cuadrado 5.0 x 5.0 m	3.819,46	3.977,19
	Cuadrado 5.5 x 5.5 m	4.151,40	4.292,02
	Cuadrado 6.0 x 6.0 m	4.506,57	4.682,65
	Rectangular 2.0 x 2.5 m	3.236,99	3.342,59
	Rectangular 2.0 x 3.0 m	3.236,99	3.342,59
	Rectangular 2.5 x 3.0 m	3.236,99	3.342,59
	Rectangular 2.5 x 3.5 m	3.332,03	3.430,13
	Rectangular 3.0 x 3.5 m	3.332,03	3.430,13
	Rectangular 3.0 x 4.0 m	3.396,18	3.501,43
	Rectangular 3.0 x 4.5 m	3.696,26	3.781,62
	Rectangular 3.0 x 5.0 m	3.759,42	3.873,54
	Rectangular 3.5 x 4.0 m	3.402,87	3.501,43
	Rectangular 3.5 x 4.5 m	3.696,26	3.781,62
	Rectangular 3.5 x 5.0 m	3.759,42	3.873,54
	Rectangular 4.0 x 4.5 m	3.731,46	3.826,15
	Rectangular 4.0 x 5.0 m	3.766,66	3.873,54
	Rectangular 4.5 x 5.0 m	3.784,26	3.927,03
	Rectangular 4.5 x 5.5 m	4.010,60	4.153,82
	Rectangular 5.0 x 5.5 m	4.086,72	4.228,31
	Rectangular 5.0 x 6.0 m	4.383,37	4.561,17
	Rectangular 5.5 x 6.0 m	4.500,89	4.682,65

Serie 9000 Max – Base fija

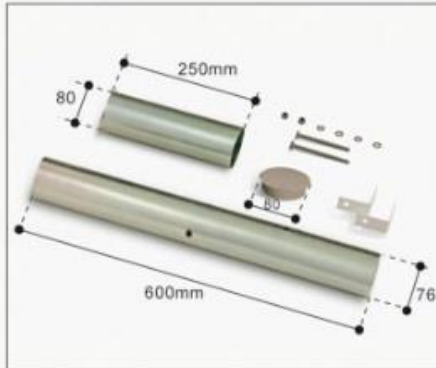

BASE CASACA. Compuesta de dos tubos, uno se empotra en el suelo y otro une el mástil del parasol con el suelo. Se incluyen dos escuadras de seguridad, y una tapa de aluminio.

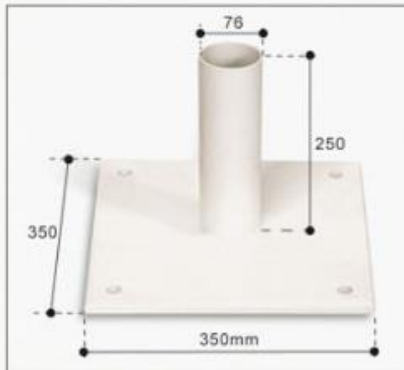

BASE PLETINA. Soporte apto para fijar en pavimentos duros. Su instalación es rápida y sencilla. Aconsejable utilizar anclajes metálicos de M10.



REFUERZO PEANA. Pieza de aluminio que fortalece y aísla la entrega del parasol con el pavimento. Sustituye a las escuadras de seguridad.

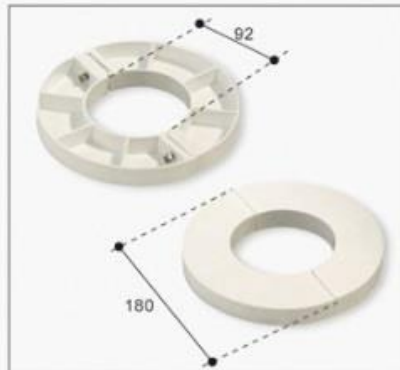

DONUT POLIETILENO. Pieza de Polietileno que se utiliza como separador para facilitar la apertura del parasol.



BASE CASACA + REFUERZO PEANA. Conjunto montado: base casaca más refuerzo peana.

Base Casaca + Refuerzo Peana

Serie 9000 Max – Base suelta

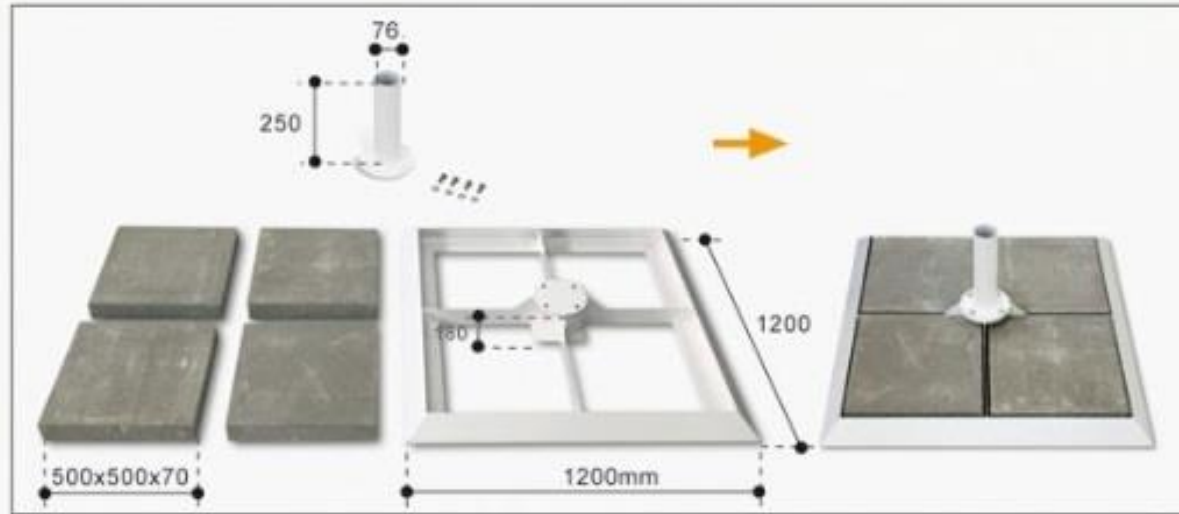

BASE LASTRE. Este accesorio se utiliza en lugares donde no está permitido perforar el pavimento. Su peso montado es de 200Kg aprox. y se compone de un marco estructural, un soporte pletina circular,

cuatro losas de 500x500mm. El marco estructural está preparado para la colocación de cuatro niveladores en las esquinas.

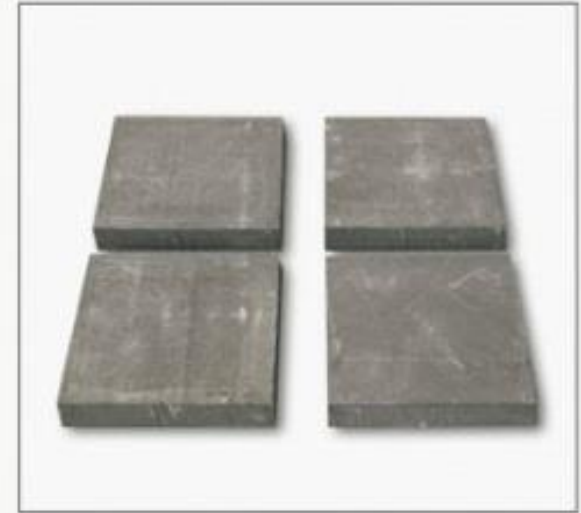

SUPLEMENTO LASTRE. Suplemento de cuatro losas que suman un total de casi 180Kg. Apto sólo para complementar Base Lastre Serie 9000.

Serie 9000 Max – Lámpara esfera



LÁMPARA ESFERA. Lámpara desmontable de tres brazos esfera. Apta para mástiles de 45mm a 90mm de diámetro. Se suministra con un cable de 1400mm, de dos hilos.

LÁMPARA ESFERA / DESMONTABLE

LÁMPARA ESFERA. Aconsejamos montarla con bombillas de bajo consumo. El embalaje hace 450x400x230mm.

Serie 9000 Max – Precios Accesorios

ACCESORIOS SERIE 9000 / 9000 MAX		PVP
Base Casaca 9000 / 9000 MAX		197,12
Refuerzo Peana 9000 / 9000 MAX		102,74
Base Pletina 9000, Lacada Blanca, 4 taladros, de 350 x 350 mm		171,60
Base Pletina 9000 MAX, Lacada Blanca, 8 taladros, de 350 x 350 mm		180,40
Base Lastre Desmontable 9000 / 9000 MAX. 1200x1200mm, 200kg (marco metálico + 4 losas)		917,40
Suplemento 4 losas (500x500x70mm, 45kg/ud)		123,20
Lámpara Esfera desmontable de tres brazos		425,70
Canal Vierteaguas (120x40mm)	precio metro lineal	90,20
Electrificación Interior de mástil		96,80
Lacado Especial de Estructura (incluye peana)	coste neto	145,53
Lacado de Base Pletina	coste neto	28,88
Lacado de Base Lastre	coste neto	46,20
Telas de colores y resinados (excepto acrílico crudo y pvc blanco)	incremento pvp parasol	+ 5%

Serie 9000 Max con cerramiento



Solero®

Serie 9000 Max conexión cerramiento

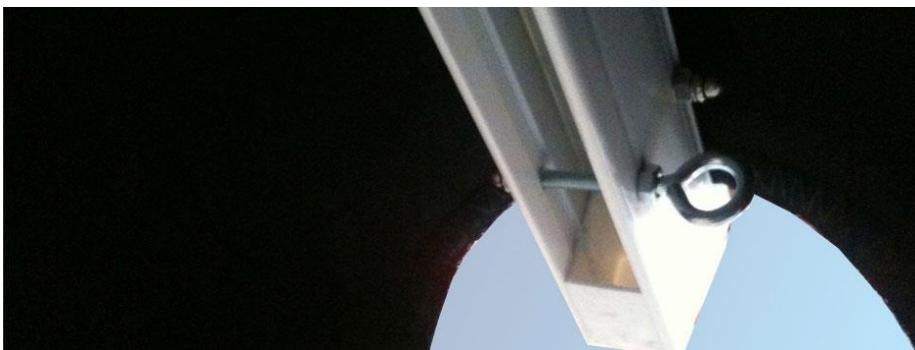
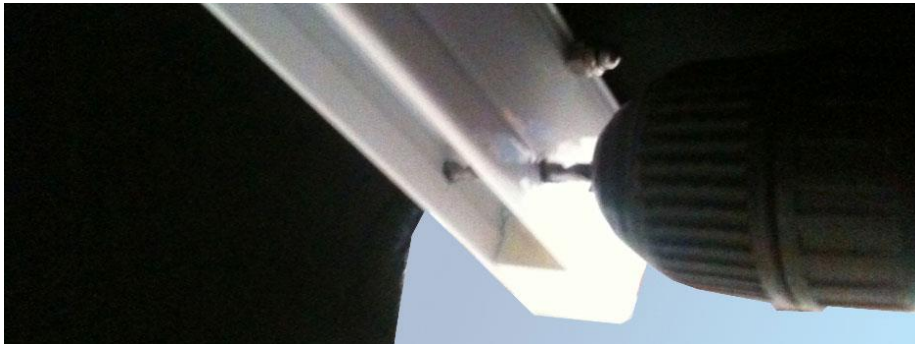

Solero®

Serie 9000 Max Cerramientos - Precios

CERRAMIENTO SERIE 9000 MAX (Precio por lateral)	2.0M	2.5M	3.0M	3.5M	4.0M	4.5M	5.0M
PVC Blanco M2 con Ventana Pequeña	781,66	839,43	897,20	976,98	1.034,75	1.114,52	1.172,29
PVC Blanco M2 con Ven. Pequeña Doble	---	---	---	---	1.342,75	1.422,52	1.480,29
PVC Blanco M2 con Ventana Grande	---	971,43	1029,20	1.108,98	1.166,75	1.246,52	1.304,29
PVC Blanco M2 (sin ventana)	473,44	531,43	589,20	633,78	726,75	806,52	864,29
PVC Transparente M2 (perfil unión)	687,63	786,41	885,24	966,42	1.083,15	1.181,62	1.280,53
PVC Transparente M2 + PVC Blanco M2	676,63	773,21	869,41	966,42	1.063,35	1.159,62	1.256,33
Canal Vierteaguas en PVC Blanco M2	302,81	318,21	333,61	447,22	462,62	478,02	493,42

*Nota: SPS, no aconseja cerramientos completos para parasoles superiores a 4 x 4 metros.

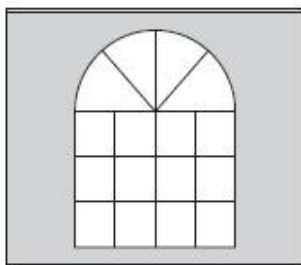

Ventana Pequeña (sólo PVC)

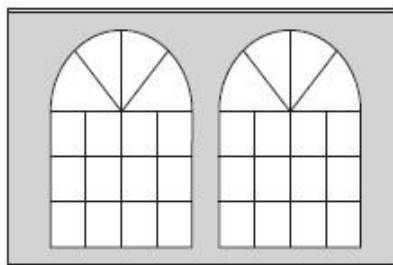

Ventana Pequeña Doble (sólo PVC)

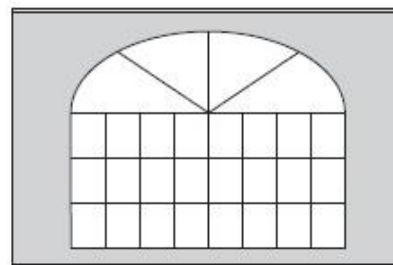

Ventana Grande (sólo PVC)

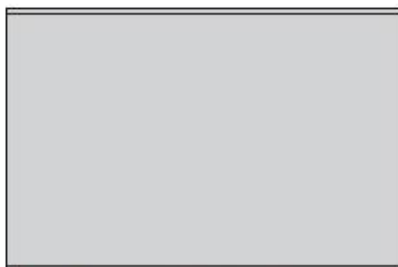

PVC o Acrílico (sin ventana)

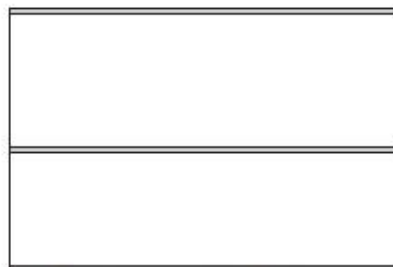

PVC Transparente (perfil unión)

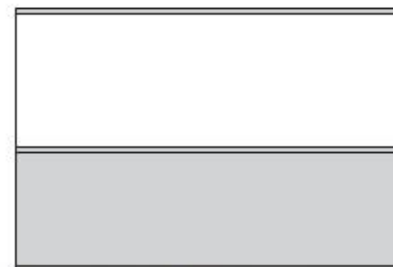

PVC Blanco o Acrílico Crudo
+ PVC Transparente (perfil unión)



Canal Vierteaguas PVC Blanco M2

Serie 9000 Max – Opcional electricidad



Solero

Serie 9000 Max – Opcional estufas y focos



Solero

Serie 9000 Max – Opcional fluorescentes



Solero®

Serie 9000 Max – Opcional LEDs

